

PRODUCT & ASSEMBLY GUIDE

Electric HiLo Combo

FOUNDATION

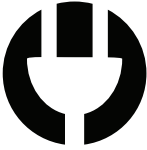

ELECTRIC



ARTICULATION

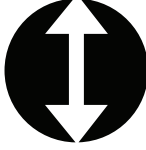

HI-LO



FIXED



MANUAL

The Electric HiLo Combo foundation elevates the head section up to 70°, the knee sections up to 35° and elevates the foundation/mattress up to 10°. Operates by corded remote control.

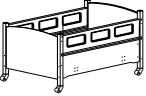

SleepSafe® (Low Bed)

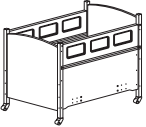

SleepSafe® II (Medium Bed)

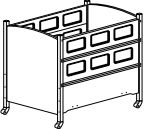

SleepSafer® (Tall Bed)
 Dual View



SleepSafe® Extension Bed
 Dual View with Extension Top

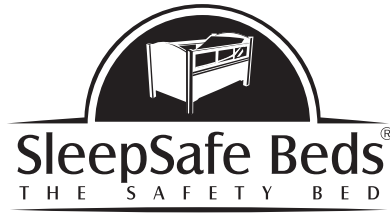

SleepSafeBed.com | 866.852.2337

3629 Reed Creek Drive | Bassett, VA 24055

Table of Contents

- 1 Pre-Assembly Information
- 2 Component Chart #1
- 3 Component Chart #2
- 4 Mattress Information
- 5 Safety Rail Adjustment Instructions
- 6, 7 Assembly Guide: SleepSafe Low Bed
SleepSafe II Medium Bed
- 8, 9 Assembly Guide: SleepSafer Tall Bed
SleepSafer Tall Bed Dual View
- 10, 11 Assembly Guide: SleepSafe
Extension Bed / Extension Top
- 12 Padding Information
- 13 Final Installation Checklist
- 14 Operator's Guide
- 15 Popular FAQ's / Maintenance
- 16 Warranty Information
- 17 DME Provider / Technical Support
- 18 Serial Number

This guide is available as a PDF. Contact Customer Service at 866.852.2337 for more information.



ELECTRIC HI-LO COMBO

Tools Needed for Assembly



Allen and Torx Wrenches
(Supplied)



Flat and Phillips Head
Screwdrivers



3/8" Open or Closed
End Wrench

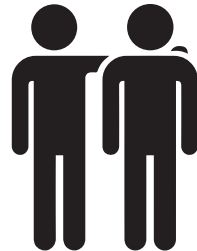

Two People for Assembly

Attention! Read Before Assembly

- **KEEP THIS PRODUCT & ASSEMBLY GUIDE.**

IT CONTAINS THE BED'S SERIAL NUMBER

- CAREFULLY REMOVE AND LAY OUT ALL COMPONENTS. FAMILIARIZE YOURSELF WITH INSTRUCTIONS TO FACILITATE THE ASSEMBLY OF YOUR BED.

- CHECK COMPONENTS AND CONTENTS OF ENCLOSED HARDWARE BAG WITH THE HARDWARE LIST ON FOLLOWING PAGES.

- KEEP THE FOUR CARDBOARD STANDS FOR ASSEMBLY AND POSSIBLE FUTURE USE.

DUE TO THE PRESENCE OF SMALL PARTS DURING ASSEMBLY, KEEP OUT OF REACH OF CHILDREN.

- IMPORTANT: FOLLOW THE INSTRUCTIONS IN THE SPECIFIED ORDER TO ENSURE THE BED IS PROPERLY ASSEMBLED.

- COMPLETE ASSEMBLY. ENSURE EACH COMPONENT IS INSTALLED. DO NOT OMIT ANY COMPONENT FROM INSTALLATION.

- NEVER USE THIS BED IF THERE ARE ANY MISSING FASTENERS, LOOSE JOINTS, BROKEN PARTS, TORN MESH, OR PADDING INADEQUACIES. CONTACT SLEEPSAFE BEDS AT 866.852.2337 FOR ASSISTANCE.

- NEVER SUBSTITUTE OR ALTER PARTS, THE PRODUCT INCLUDING SIDE RAILS, MUST BE FULLY INSTALLED PRIOR TO USE.

- IF BED IS PADDED, CHECK THAT ALL PADDING IS FIRMLY ATTACHED.

- WARNING STRANGULATION HAZARD: STRINGS CAN CAUSE STRANGULATION! NEVER PLACE BED NEAR WINDOW WHERE CORDS FROM BLINDS OR DRAPES ARE IN REACH OF A CHILD.

- KEEP REMOTE CONTROL CORD AWAY FROM BED WHILE MOVING THE SAFETY RAIL UP OR DOWN TO PREVENT PINCHING OF THE CORD.

- KEEP REMOTE CONTROL CORD AWAY FROM BED'S INTERIOR TO PREVENT ENTANGLEMENT AND STRANGULATION

- AN UNINTERRUPTED POWER SUPPLY (UPS) UNIT IS RECOMMENDED IN THE EVENT OF A POWER OUTAGE.



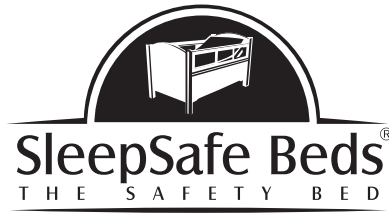





- DO NOT SUBSTITUTE MATTRESS. IT IS SPECIFICALLY DESIGNED AND FITTED FOR A SLEEPSAFE® BED AND ITS USER.

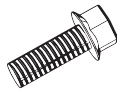

SleepSafeBed.com | 866.852.2337

3629 Reed Creek Drive | Bassett, VA 24055

Included Components for Assembly

		SLEEPSAFE (Low Bed)	SLEEPSAFE II (Medium Bed)	SLEEPSAFER (Tall Bed)	SLEEPSAFE Extension Bed	SLEEPSAFE Extension Bed with Top	SLEEPSAFER (Dual View) Extension Bed	SLEEPSAFE (Dual View) Extension Bed with Top
Cardboard Lift 		4	4	4	4	4	4	4
90 mm Allen Bolt 		8	12	16	28	28	12	28
3/4" Hex Bolt 		8	8	8	8	8	8	8
Barrel Nut (If the bed is <u>unpadded</u>) 		8	12	16	28	28	12	28
Safety Rail Hinge Guard Assembly 		2	2	1	1	1	2	2
Allen / Torx Wrench Set (3 sizes) 		1	1	1	1	1	1	1
Square Bit Driver 		1	1	1	1	1	1	1
Casters (Attached) 		4	4	4	4	4	4	4
Extension Bed Safety Latch & 2 Screws 					1	1	2	2









ELECTRIC HI-LO COMBO

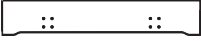
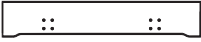
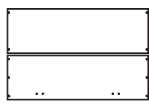

SleepSafeBed.com
1-866-852-2337

3629 Reed Creek Dr. | Bassett, VA 24055

Included Components for Assembly

	SLEEPSAFE (Low Bed)	SLEEPSAFE II (Medium Bed)	SLEEPSAFER (Tall Bed)	SLEEPSAFE Extension Bed	SLEEPSAFE Extension Bed with Top	SLEEPSAFER (Dual View) Extension Bed	SLEEPSAFER (Dual View) Extension Bed with Top
Electric Hi-Lo Frame 	1	1	1	1	1	1	1
Mattress 	1	1	1	1	1	1	1
Headboard and Footboard Set 	1	1	1	1	1	1	1
Side Panel 	2	2					
Front Panel 			1	1	1	2	2
Back Panel 			2	2	2		
Safety Rail 	2	2	2	2	2	4	4
Extension Bed End Panel 				2	2		2
Extension Bed Side Panel 				2	2		2
Extension Bed SuperScreen Top 					1		1

SleepSafe Bed Mattress Information

SleepSafe Bed® – Our Memory Foam Mattress with Gel Technology

SleepSafe® Bed mattress support surface provides optimized pressure redistribution, rapid heat dissipation, and increases breathability compared to standard foam.

- Reduced incidence of pressure ulcers by channeling heat away from the body much faster than standard foam, virtually ridding perspiration moisture.
- Superior pressure redistribution achieved by providing more support and less cradling at higher levels of compression, distributing pressure over a larger surface area and eliminating static fatigue.

How Does It Work?

The technology works by allowing air to pass through open cells, channeling it away from the body instead of trapping it within the closed cells of traditional memory foam. The infusion of gel polymers throughout the foam contributes both cooling properties and the virtual elimination of static fatigue. As a result of the marriage between open cell foam and gel infusion, the mattress holds its shape better, redistributes pressure over a larger surface area, and successfully wicks heat away from the body, leaving patients cool, dry, and comfortable.

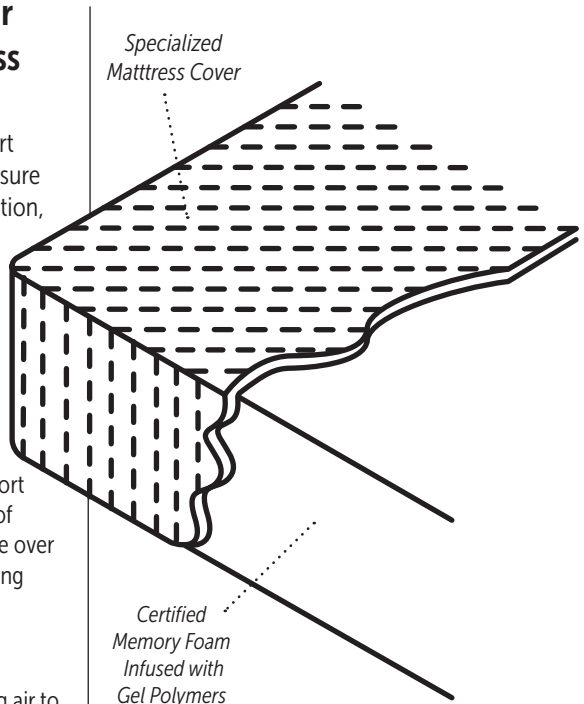

Foam products meet the following criteria:

- Low Emissions (VOC's)
- BPA Phthalate – Free
- CFC – Free
- BHT – Free
- PBDE – Free
- Emissions – Tested
- Content – Tested
- Performance – Tested
- Made without Ozone Depleters
- Mercury, Lead and Heavy Metal Free
- Made without Formaldehyde
- Methylene Chloride – Free
- Environmentally Innovative
- Material Certification

Other notes about the foam in mattresses:

- Foam products use a blend of natural oil-based and conventional polyols.
- Benefits farmers looking for a new market for crops.
- Polyol is made partially from plant-based renewable oils such as soy bean and castor beans.



ELECTRIC HI-LO COMBO



SleepSafeBed.com

1-866-852-2337

3629 Reed Creek Dr. | Bassett, VA 24055

Safety Rail Adjustment: Up and Down

1 Does the Safety Rail need adjustment?

For proper operation, the pin should be centered in the strike. If not centered, follow these steps to center the pin in the strike.

2 Remove Strike from Bed Post.

Use Drill with Torx bit to remove screws from the Strike. Gently tap the strike out of the bed post with hammer or mallet to access.

3 Adjust Set Screw.

Use Torx 10 wrench to adjust set screw. Keep in mind which direction that you need to adjust the pin. If the pin needs to be raised, turn the set screw clockwise. If the pin needs to be lowered, turn the set counter-clockwise.

4 Reinsert Strike into Bed Post.

Check to see if the Pins are centered properly within the Strikes.

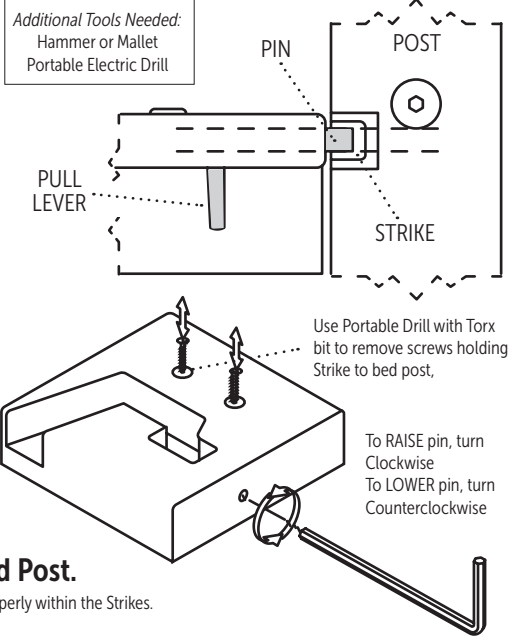

Safety Rail Adjustment: Side by Side

1 Does the Safety Rail need adjustment?

When up and secure, check the spacing between the end of the safety rail and the headboard and footboard legs. They should be spaced evenly.

2 Remove Safety Rail and adjust the play.

If spacing is not even, or there is too much side-to-side play in the rail, turn the black hex bolt using the 1/4" Allen Wrench provided.

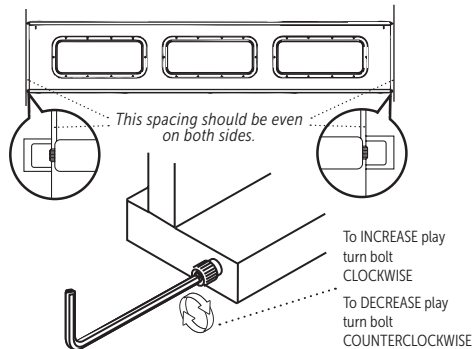

ELECTRIC HI-LO COMBO



SleepSafeBed.com

1-866-852-2337

3629 Reed Creek Dr. | Bassett, VA 24055

Assembly Guide

✓ SleepSafe (Low Bed)

✓ SleepSafe II (Medium Bed)

After unpacking bed and checking the contents

1

Set HiLow Foundation on 4 provided cardboard lifts.

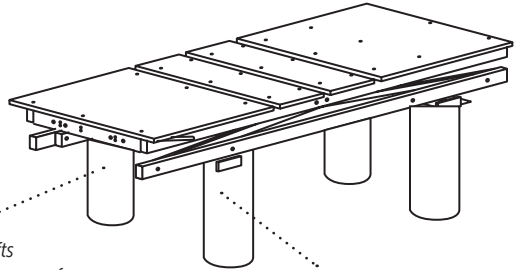

When placing cardboard lifts beneath foundation, allow room for both side panels to be attached.

Save cardboard lifts for future use!

2

Insert Barrel Bolts into Side Panels.

(Note: Barrel Bolts are pre-inserted on padded beds)

Align and push in Barrel Nut as shown. Use flathead screwdriver for assistance.

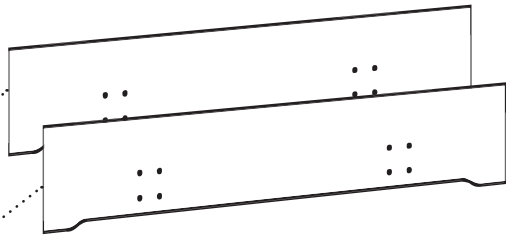
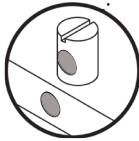

*SleepSafe Bed (Low Bed) Side Panels use 8 Barrel Bolts
SleepSafe II (Medium Bed) Side Panels use 12 Barrel Bolts*

3

Attach Side Panels to foundation.

(Use 3/8" wrench to install eight 3/4" Hex Bolts inside the panel)

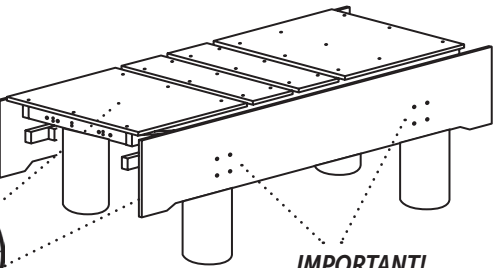

Use 4 Hex Bolts inside each panel.

IMPORTANT!

*Choose depth for the mattress to floor height.
Low setting provides more safety rail height.*



ELECTRIC HI-LO COMBO



SleepSafeBed.com

1-866-852-2337

3629 Reed Creek Dr. | Bassett, VA 24055

4 Attach Headboard and Footboard to Side Panels.

(Use 4mm Allen Wrench to fasten 90mm Allen Bolts to Side Panels)

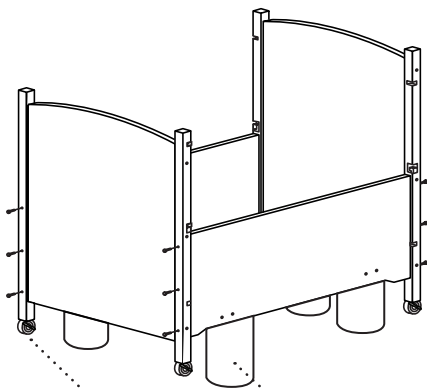
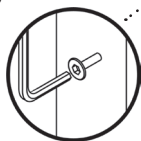

*SleepSafe Bed (Low Bed) uses (8) 90mm Bolts
SleepSafe II (Medium Bed) uses (12) 90mm Bolts*

Casters are pre-installed

Once headboard and footboard are attached, remove cardboard lifts.

5 Install Mattress.

Do not substitute the mattress as it designed specifically for SleepSafe® Beds. Further information is available on Page 4.

6 Install Safety Rails

When safety rail is in the down position, first **insert** the safety rail hinge pin into the headboard strike, then **slide** the safety rail hinge pin into the footboard strike.

Step 2

SLIDE the safety rail hinge pin into the bottom of the footboard strike.

Strike
Hinge Pin

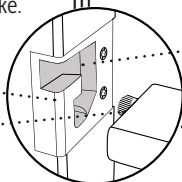

Step 1

INSERT the hinge pin into the headboard strike below the hinge guard.

Hinge Guard

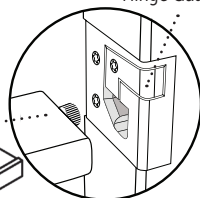

Step 3

Follow enclosed instructions

Install footboard hinge guard into footboard strike.

IMPORTANT: Before Step 3, check the Safety Rails, as they may need to be adjusted to operate properly. Page 5 has instructions. The hinge pins need to be adjusted evenly on both sides to fit properly when inserted into the posts.

IMPORTANT: Once installed, use both hands to bring the safety rail up and attach it to the posts. Verify that it latches securely to both posts,

Assembly Guide

✓ SleepSafer (Tall Bed)

✓ SleepSafer (Dual View)

After unpacking bed and checking the contents

1

Set HiLow Foundation on 4 provided cardboard lifts.

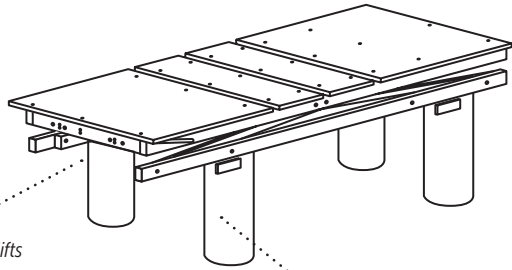

When placing cardboard lifts beneath foundation, allow room for both side panels to be attached.

Save cardboard lifts for future use!

2

Insert Barrel Bolts into Back and Front Panels.

(Note: Barrel Bolts are pre-inserted in padded beds)

Align and push in Barrel Nut as shown. Use flathead screwdriver for assistance.

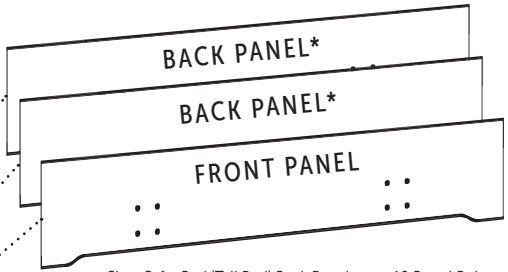
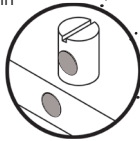

*SleepSafer Bed (Tall Bed) Back Panels uses 10 Barrel Bolts
SleepSafer Bed (Tall Bed) Front Panel use 6 Barrel Bolts*

** Dual View Option uses 2 Front panels only. No Back Panels.*

3

Attach Panels to foundation.

(Use 3/8" wrench to install eight 3/4" Hex Bolts inside the panel)

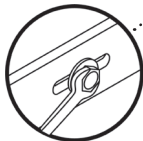

Use 4 Hex Bolts inside each panel.

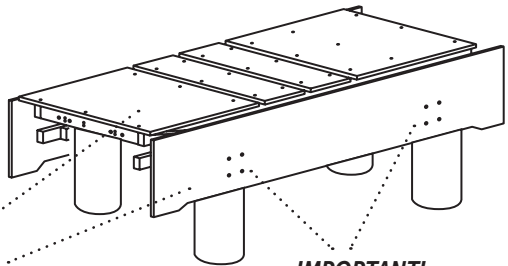

IMPORTANT!

Choose depth for the mattress to floor height. Low setting provides more safety rail height.



ELECTRIC HI-LO COMBO



SleepSafeBed.com

1-866-852-2337

3629 Reed Creek Dr. | Bassett, VA 24055

4 Attach Headboard and Footboard to Panels.

Fasten (6) 90mm Allen Bolts to each panel with 4mm Allen Wrench.

5 Install Back Panel.

Set in place with alignment pins, then fasten with (2) 90mm Allen Bolts to each post.

NOTE: This step not necessary for Dual View option

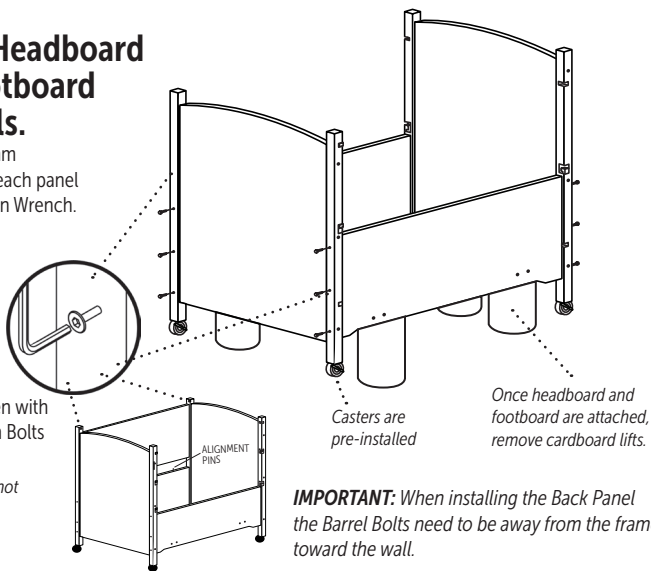

IMPORTANT: When installing the Back Panel the Barrel Bolts need to be away from the frame, toward the wall.

6 Install Mattress.

Do not substitute the mattress as it designed specifically for SleepSafe® Beds. Further information is available on Page 4.

7 Install Safety Rails

When the bottom safety rail is in the down position, **insert** the hinge pin into the headboard strike, then **slide** the hinge pin into the footboard strike. For SleepSafer Tall Beds, and SleepSafe Extension Beds, both hinge pins on the top rail slide into the strikes.

Step 2

SLIDE the safety rail hinge pin into the footboard strike of the bottom safety rail.

Strike
Hinge Pin

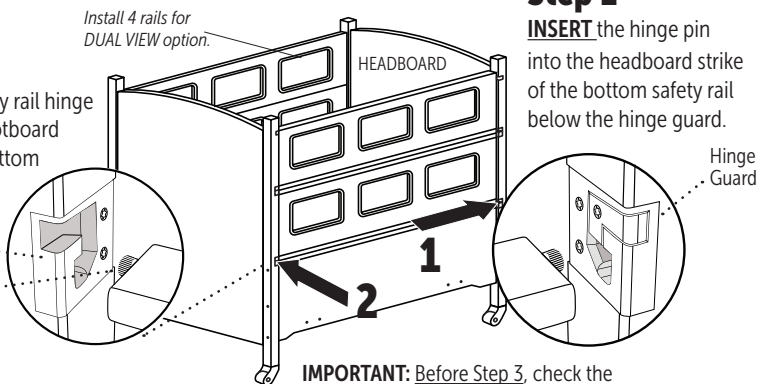

Step 1

INSERT the hinge pin into the headboard strike of the bottom safety rail below the hinge guard.

Step 3

Follow enclosed instructions

Install footboard hinge guard into footboard strike. Then, install top safety rail(s), without hinge guards.

IMPORTANT: Before Step 3, check the Safety Rails, as they may need to be adjusted to operate properly. Page 5 has instructions. The hinge pins need to be adjusted evenly on both sides to fit properly when inserted into the posts.

IMPORTANT: Once installed, use both hands to bring the safety rail up and attach it to the posts. Verify that it latches securely to both posts.

Assembly Guide

✓ SleepSafe® Extension Bed
(w/SUPERSCREEN Top)

After unpacking bed and checking the contents

1

Set Extension Side Rails Upside Down and on their Legs.

Assemble this with two people, otherwise one person can assemble one panel at a time after the the rest of the bed is assembled.

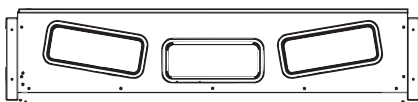

Legs are upside down.

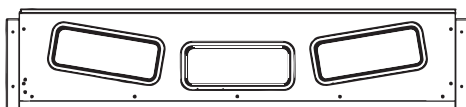

2

Attach Extension Ends to Side Rails. Flip Assembly Over.

Illustration shows assembly upside down. Flip unit over when assembly is completed.

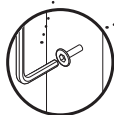
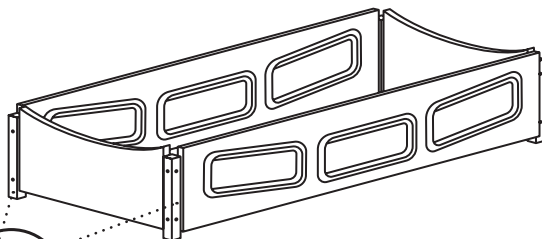

Before flipping unit over, use 4mm Allen Wrench to fasten (8) 90mm bolts, 2 per post, on each side of the assembly.

3

If equipped, attach the SUPERSCREEN TOP to the Extension with Trim-Lok.

Trim-Lok is sewn into the edges of the Top. Attach to Extension by snapping the Trim-Lok into the grooves on the edge of the Extension.

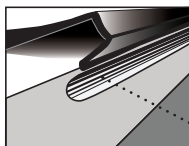

Trim-Lok Snaps into Groove Channel

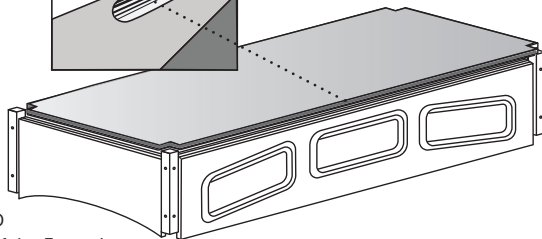

ELECTRIC HI-LO COMBO



SleepSafeBed.com

1-866-852-2337

3629 Reed Creek Dr. | Bassett, VA 24055

4

This SleepSafe® Extension Bed installation step is based on ordering it as a complete unit.

Retrofitting an extension to a SleepSafer® Tall Bed requires additional instructions.

A Loosen top bolts on all 4 bed posts.

This allows play in the frame to fit the Extension.

B Set the Extension on top of bed posts.

Extension posts should align with the bed posts.

C Fasten Extension to the Bed.

Fasten (1) 90mm Allen Bolt into each post to attach Extension. Tighten all bolts.

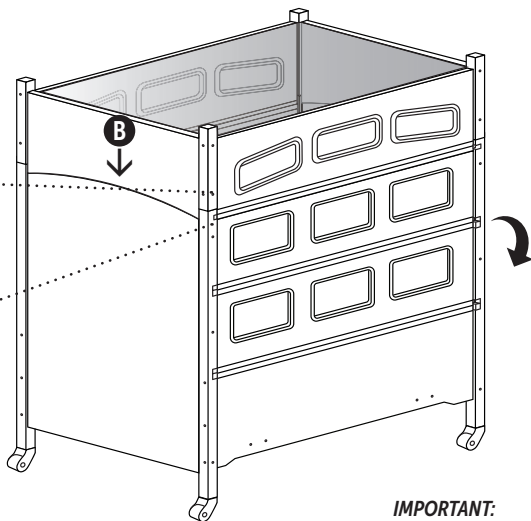

IMPORTANT:

Bottom Safety Rail pivots down. Use both hands to carefully operate.

5

Install Safety Latch to Extension.

Align safety latch to threaded inserts located in the predrilled holes in the Extension. Use Phillips head screwdriver to mount the latch to the Extension.

The latch will catch and secure the top safety rail when raised into position.

Use hand to push latch up to release the rail.

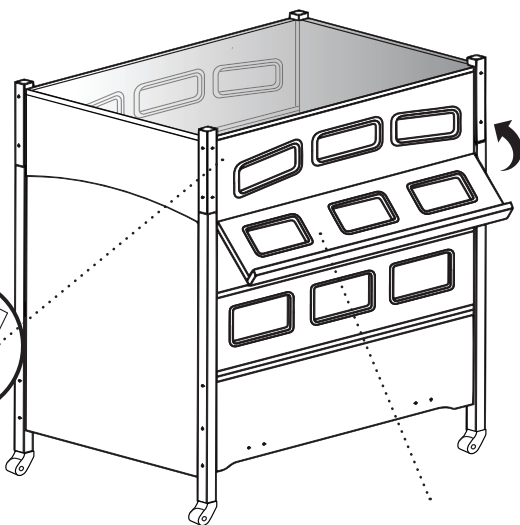
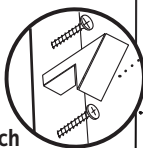

IMPORTANT:

Be sure to support safety rail with both hands while moving the rail into their secure positions.

SleepSafe Bed Padding Information

Materials:

- 70 Denier Nylon Fabric Cover with a Fluid Resistant Healthcare Coating
- 3/4" High Density Foam Padding

Padding Features:

The safety rail pads extend up and over the rails and attach to the outside of the safety rails. The headboard and footboard pads extend to the top and to the edges of the legs of headboard and footboard.

- Padding covers the corner posts
- Anti-Static
- Non-allergenic
- Bacteria Resistant
- Stain Resistant
- Malodor Protection
- Fluid Resistant
- Fungal Resistant
- Flame Retardant
- Tear Resistant

Padding Attachment:

- Trim-Lok secures padding to the Safety Rails. Velcro® secures padding to the inside panels.

Padding Maintenance

- For cleaning, use warm water and a mild cleanser. If the padding is over the windows, it can be removed and cleaned. If the padding is around the windows, please do not remove. It is best to clean the padding in its place.
- Do not machine wash.

Important Note:

- Padding is installed at the factory and will cover ALL 4 sides. Padding only 1 or 2 sides is NOT an option.
- Padding removal causes gaps between the mattress and the bed's interior.

Padding questions?

- Please contact customer service for any specific information about padding.

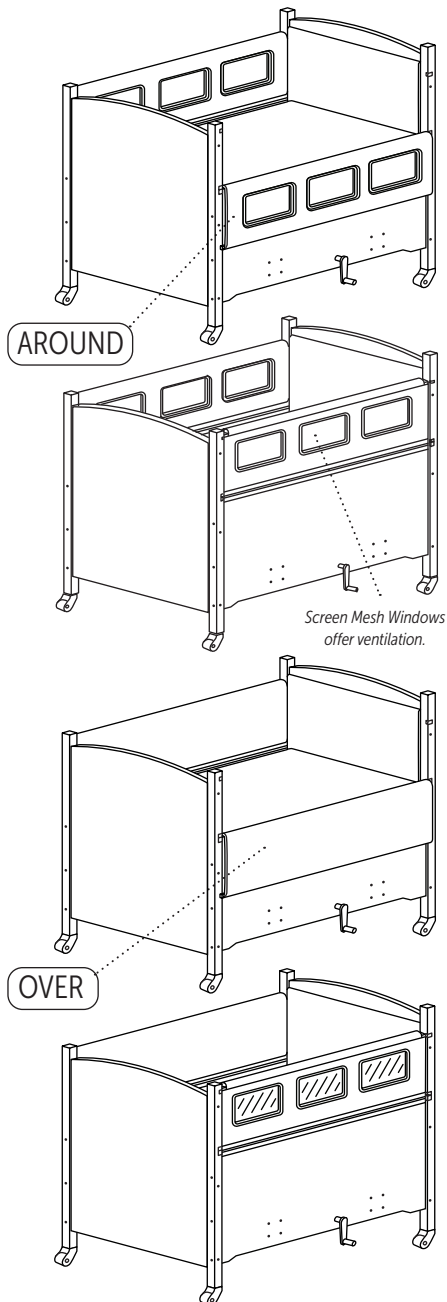

Final Bed Installation Checklist

1

Check all bolts to see that they are tight.

Be sure all fasteners that hold the components are hand tightened with wrenches.

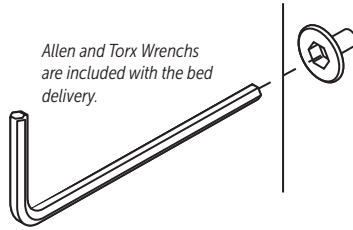

2

Check Safety Rails to be sure they operate and latch properly.

Safety Rails should pivot correctly, align properly and securely latch into the gate located on the bed posts.

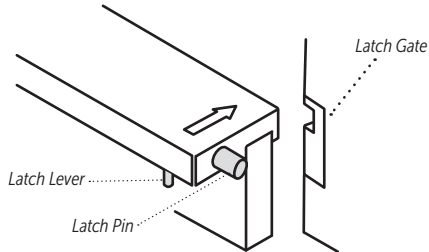

3

Check fit between headboard, footboard, bed sides and mattress.

The mattress should always fit snugly against the sides. If not, contact the DME or Customer Service at SleepSafe Beds.

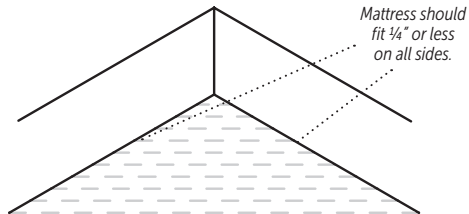

4

Check Bed Operation with the Remote.

The Electric HiLo Combo should move about 70° for the head and about 35° for the knee. The HiLo range is 10" up and down. Test these features thoroughly.

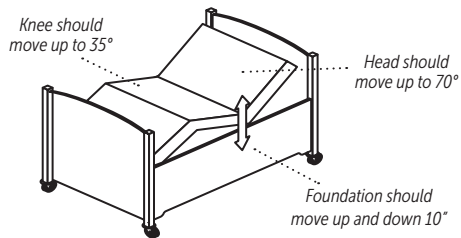

5

For Extensions, check operation of Safety Latch holding the top Safety Rail.

Top Safety Rail should set in place when lifted up and into place on the Extension.

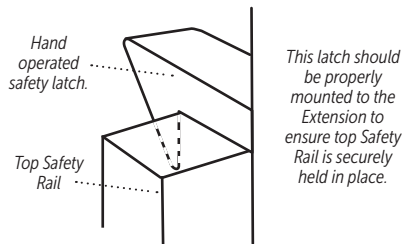

Operator's Guide: Electric Hi Lo Combo

Operating the HiLo Combo Foundation with the Remote.

This foundation uses a corded remote to control 3 functions:

- 1) Controls mattress height 10"
- 2) Controls head elevation to 70°
- 3) Controls knee elevation to 35°

REMOTE LOCK OUT Procedure:

Press and HOLD BOTH DOWN BUTTONS on HEAD and FOOT articulation functions for about 5 seconds. The LIGHT on the REMOTE will FLASH when it is locked. To UNLOCK, repeat his procedure.

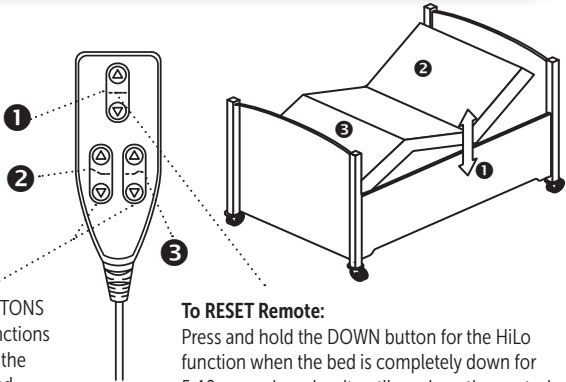

To RESET Remote:

Press and hold the DOWN button for the HiLo function when the bed is completely down for 5-10 seconds and wait until you hear the control box click. This indicates normal functionality.

Handling, operating and securing the Safety Rails.

The top Safety Rail on the SleepSaver® (Tall Bed) is removable. The top Safety Rail on the SleepSafe® Extension Bed is not removable because it flips up and latches onto the extension.

It is always recommended to handle the Safety Rails gently and firmly with both hands. Be sure both sides of the Safety Rail are securely attached to the post before leaving the bed alone.

IMPORTANT: USE BOTH HANDS WHEN OPERATING SAFETY RAILS AND BE SURE THAT BOTH SIDES ARE SECURED ON THE POSTS.

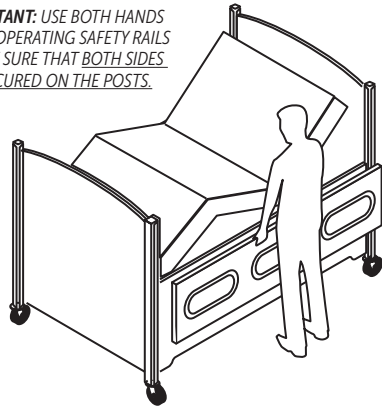

How the Casters Work.

The casters are pre-installed at the factory in the bottom of the headboard and footboard legs. It is recommended that the casters are locked when the bed is in use to add to the bed's stability. The casters are locked when the tab is in the down position. Unlocked when the tab is up.

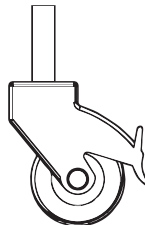

LOCKED

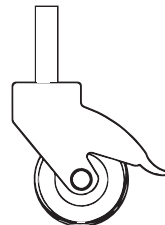

UNLOCKED



ELECTRIC HI-LO COMBO



SleepSafeBed.com

1-866-852-2337

3629 Reed Creek Dr. | Bassett, VA 24055

Frequently Asked Questions

How do I get replacement parts? What should I do if I have a repair problem?

Please call your Durable Medical Equipment (DME) provider that helped you purchase the bed. They should be able to help with any problem you may have. If your original DME provider cannot help you with replacement parts or repair, please contact us directly at 866-852-2337 so we may assist you.

Is there a battery backup system for beds using electricity in case of a power failure?

Yes. Battery backup systems (UPS) are typically available from office supply retailers. We recommend that you purchase a UPS battery back up unit such as APC's ES 750. This unit will give enough power to operate the bed for a limited time. This unit has 6 battery powered outlets to provide power for other devices as well.

My child's medical needs have changed. Can I change the foundation?

Yes. Most SleepSafe® Bed foundations can be converted to another bed. To convert a SleepSafe Bed foundation, you will need to purchase a Conversion Kit from SleepSafe® Beds. Insurance may or may not cover the additional cost of the conversion kit. It may be necessary to submit another letter of medical necessity justifying the change. You will need to make the purchase through your local DME provider of SleepSafe® Beds. Give us a call, toll-free, at 866-852-2337 for more information about SleepSafe® Bed conversions. We will be happy to assist you.

Can I buy a replacement mattress?

Yes, a replacement mattress may be purchased for your SleepSafe® Bed. Our mattresses are custom made to fit your SleepSafe® Bed based on whether the bed is padded or unpadded. Also, if the mattress was ordered for a SleepSafe Bed® with custom dimensions, it will need to be repaced accordingly. All SleepSafe® Bed mattresses are designed to avoid possible injury by reducing the gaps between the mattress and the sides of the bed. This is designed to reduce the chances of burrowing or entrapment.

How do I clean my SleepSafe® Bed?

All surfaces of a SleepSafe® Bed can be cleaned with water and mild detergent using a soft cloth. Please avoid any abrasives and solvents.

Annual Maintenance Checklist

- Tighten all bolts on panels and posts.***
Use provided Torx and Allen Wrenches to hand tighten. Avoid power tools.
- Lubricate working components beneath the bed.***
Lubricate the pins, actuators and hinges.
- If necessary, adjust Safety Rails to insure proper operation.***
See page 10 for instructions on how to adjust the position of the safety rail side by side and up and down.

Bed/Mattress Warranty Information

Full One-Year SleepSafe® Bed Warranty

The SleepSafe® Bed is warranted against defects in workmanship or components for a period of one year from the date of purchase. Sleep Safe Beds, LLC will repair or replace any defective part at no cost to the purchaser if the shipping of the part is within the continental United States.

Limited Five Year SleepSafe® Bed Warranty

During the second through fifth years from the date of purchase, SleepSafe Beds, LLC will replace any part found to be defective. Purchaser shall pay all service and shipping costs related to the replacement of the defective part.

Terms and Conditions for SleepSafe® Bed Warranty

A SleepSafe® Bed is expressly prescribed for a single user. This warranty will cover the bed for this user only. Warranty coverage beyond this use is handled on a case by case basis. This warranty applies to normal use and does not cover any damage caused by excessive wear, abuse, misuse, mishandling or modification of the product.

SleepSafe® Bed Mattress Warranty Information

All SleepSafe® Bed models are shipped with a CertiPUR-US® memory foam mattress with gel infused technology. This support surface provides optimized pressure redistribution rapid heat dissipation and increases in breathability compared to standard foam. Memory foam infused with gel polymers is designed for patient comfort as well as clinical superiority. Benefits include: reduced incidence of pressure ulcers by channeling heat away from the body significantly faster than standard foam, virtually eliminating perspiration moisture. The mattresses are water resistant, but are not waterproof.

Full One-Year Warranty for SleepSafe® Bed Mattress

Full one year warranty from date of purchase. SleepSafe® Beds, LLC will replace the mattress due to a defect in the materials and workmanship of the mattress, at no cost to the purchaser.

Limited Five Year Warranty for SleepSafe® Bed Mattress

During the second to fifth year, SleepSafe® Beds, LLC will replace the mattress due to a defect in the materials or workmanship of the mattress, with the shipping costs to be paid by purchaser.

Terms and Conditions for SleepSafe® Bed Mattress Warranty

Any breakdowns or deterioration of the product caused by factors other than a defect in the materials and workmanship of the mattress, such as repeated exposures to bodily fluids by incontinence, are not covered by this warranty.



ELECTRIC HI-LO COMBO



SleepSafeBed.com

1-866-852-2337

3629 Reed Creek Dr. | Bassett, VA 24055

Durable Medical Equipment Provider

Bed Serial # _____

Installation Date _____

DME Provider _____

DME Contact _____

DME Address _____

DME Phone _____

DME Email _____

Installed by _____

Customer Service & Technical Support

SleepSafe Bed Support

Hours: 8 AM to 5 PM / M-F / EST

Toll Free: 866.852.2337

Local: 276.627.0088

Fax: 276.627.0234

Web: SleepSafeBed.com

In case of an EMERGENCY after hours, please call 866-852-2337 for instructions on how to access the on-call technician.

DME Provider Support

DME: _____

Contact: _____

Phone: _____

Email: _____

Web: _____



SleepSafeBed.com | 866.852.2337

3629 Reed Creek Drive | Bassett, VA 24055

WI-820.120-7 Electric Hi-Lo Combo [7] Rev. 05